

KLT-E4MPF-OV9281 V3.0

OmniVision OV9281 グローバルシャッター MIPI そして DVPパラレル インターフェース
固定焦点 1MP カメラモジュール



カメラモジュール番号	KLT-E4MPF-OV9281 V3.0
イメージセンサー	OV9281
EFL	2.09 mm
F.NO	2.4
ピクセル	1296 x 816
視野角	146°(D) 117°(H) 67°(V)
レンズタイプ	1/4 インチ
レンズ寸法	8.00 x 8.00 x 13.52 mm
モジュールサイズ	120.00 x10.00 mm
モジュールのタイプ	固定焦点
インターフェース	MIPI そして DVPパラレル

嵌合コネクタ部品番号: **DF30FC-24DS-0.4V**

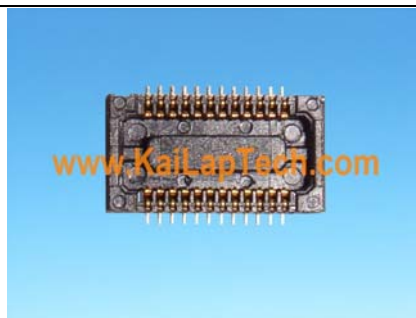

メインボードのコネクタを接続します。別売りされている。

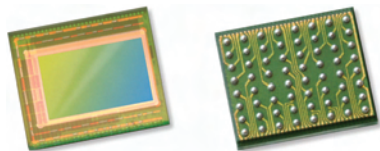

OV9281-OV9282 1-megapixel product brief



1-Megapixel OmniPixel3-GS™ Sensors for Computer Vision Applications



available in
a lead-free
package

OmniVision's OV9281 and OV9282 are high-speed global shutter image sensors that bring 1-megapixel resolution to a wide range of consumer and industrial computer vision applications, including augmented reality (AR), virtual reality (VR), collision avoidance in drones, bar code scanning and factory automation. Built on OmniVision's OmniPixel3-GS™ pixel technology, the OV9281 and OV9282 feature a high-speed global shutter pixel with best-in-class near-infrared (NIR) quantum efficiency (QE) to meet high-resolution and low-latency requirements.

Special features of the OV9281 and OV9282 include region of interest (ROI) selection and context switching. This allows some of the camera settings to change dynamically as fast as alternating frames. The sensors are available in both narrow and wide chief ray angle (CRA) settings.

The 1/4-inch OV9281 and OV9282 capture 1280 x 800 resolution images at 120 frames per second (fps) and VGA resolution at 180 fps with 2-lane MIPI and DVP output. The OV9281 and OV9282 also feature support for frame synchronization and dynamic defective pixel correction.

The OV9281 has a chief ray angle (CRA) of 9 degrees and comes in a chip scale package (CSP). The OV9282 features a CRA of 27 degrees and is available in a reconstructed wafer (RW) format. Both sensors are currently available in volume production.

Find out more at www.ovt.com.



Applications

- Consumer HMD
- Drones
- Machine Vision
- PCNB

Product Features

- 3 μm x 3 μm pixel with OmniPixel3-GS™ technology
- automatic black level calibration (ABLC)
- programmable controls for:
 - frame rate
 - mirror and flip
 - cropping and windowing
- support output formats: 8/10-bit RAW
- fast mode switching
- supports 2x2 monochrome binning
- two-lane MIPI serial output interface
- DVP parallel output interface
- supports horizontal and vertical 2:1 and 4:1 monochrome subsampling
- support for image sizes:
 - 1280 x 800
 - 1280 x 720
 - 640 x 480
 - 640 x 400
- embedded 256 bits of one-time programmable (OTP) memory for part identification
- two on-chip phase lock loops (PLLs)
- LED PWM
- built-in strobe control

OV9281-OV9282

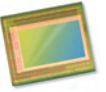

Ordering Information

- OV9281-H64A (b&w, lead-free, 64-pin CSP5)
- OV9282-GA4A (b&w, lead-free, 200 μm background, reconstructed wafer with good die)

Product Specifications

- active array size: 1296 x 816
- power supply:
 - core: 1.2V (nominal)
 - analog: 2.8V (nominal)
 - I/O: 1.8V (nominal)
- power requirements:
 - active: 134 mW
 - standby: 65 μA
 - XSHUTDOWN: 50 μA
- temperature range:
 - operating: -30°C to +85°C junction temperature
 - stable image: 0°C to +50°C junction temperature
- output interfaces:
 - 2-lane MIPI serial output and DVP parallel output
- output formats: 8/10-bit RAW
- lens size: 1/4"
- lens chief ray angle:
 - OV9281: 9° linear
 - OV9282: 26.78° non-linear
- input clock frequency: 6 - 27 MHz
- scan mode: progressive
- maximum image transfer rate:
 - 1280 x 800: 120 fps
- minimum exposure time: 1 row period
- maximum exposure time:
 - frame length - 12 row periods, where frame length is set by registers [0x380E, 0x380F]
- pixel size: 3 μm x 3 μm
- image area: 3896 μm x 2453 μm
- package dimensions:
 - OV9281 CSP5: 5237 μm x 4463 μm
 - OV9282 RW: 5252 μm x 4478 μm

Functional Block Diagram

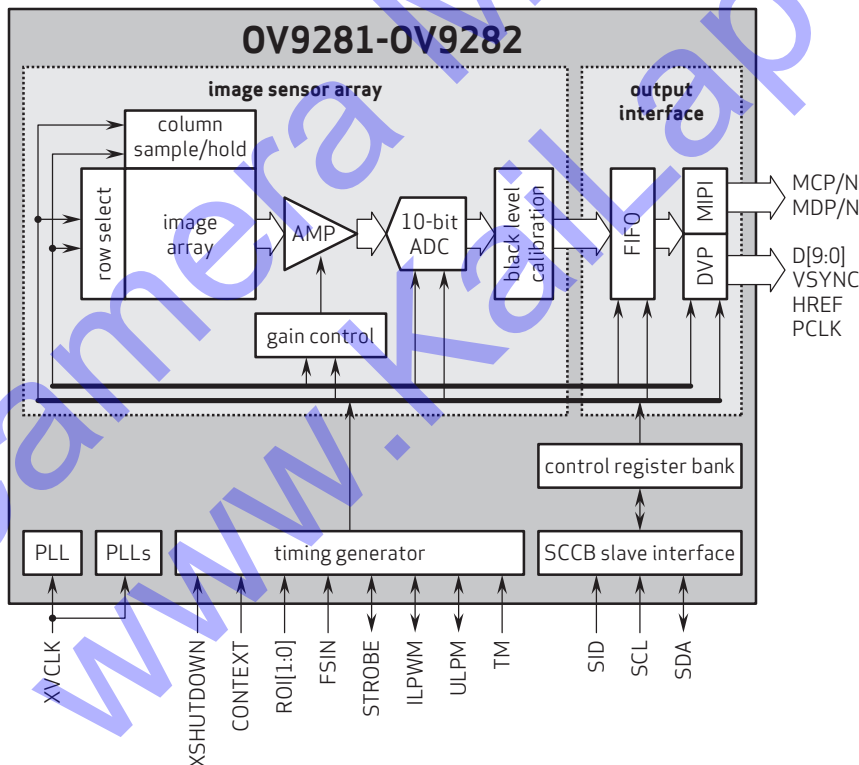

4275 Burton Drive
Santa Clara, CA 95054
USA

Tel: + 1 408 567 3000
Fax: + 1 408 567 3001
www.ovt.com

OmniVision reserves the right to make changes to their products or to discontinue any product or service without further notice. OmniVision, the OmniVision logo and OmniPixel are registered trademarks of OmniVision Technologies, Inc. OmniPixel3-GS is a trademark of OmniVision Technologies, Inc. All other trademarks are the property of their respective owners.



OmniVision